



FICHA TÉCNICA DE PRODUCTO ADLER
ADLER PRODUCT SPECIFICATION SHEET

CATEGORÍA DE PRODUCTO	PRODUCT CATEGORY
CAJA DE PASO	JUNCTION BOX
NUMERO DE PARTE	PART NUMBER
CP 10X10 (10 cm X 10 cm) - (BLANCO)	CP 10X10 (4" X 4") - (WHITE)
CP 10X10 G (10 cm X 10 cm) - (GRIS)	CP 10X10 G (4" X 4") - (GRAY)
PESO (APROX)	WEIGHT (APPROX)
190 g	6,7 oz

DATOS TÉCNICOS		TECHNICAL DATA	
MATERIAL DE FABRICACIÓN	PVC RIGIDO	MANUFACTURING MATERIAL	RIGID PVC
COLOR	BLANCO / GRIS	COLOR	WHITE / GRAY
GRADO DE PROTECCIÓN IP	IP 65	IP PROTECTION DEGREE	IP 65
GRADO DE PROTECCIÓN IK	IK 05	IK PROTECTION DEGREE	IK 05
ENVOLTURA DE SELLADO	PERFIL REDONDO EN PVC (Ø2mm)	SEALING GASKET	PVC ROUND PROFILE (Ø 0.08 In)
VOLUMEN INTERNO (APROX)	565 cm ³	INNER VOLUME (APROX)	0.565 L
AREA EFECTIVA BASE (APROX)	115 cm ²	BASE EFFECTIVE AREA (APROX)	17.5 In ²
TIPO DE CIERRE	TORNILLOS (#6 X 1/2" - 3/4") 4 UNIDADES	FASTENER TYPE	SCREW (#6 X 1/2" - 3/4") 4 UNITS
PRECINTO DE SEGURIDAD	AGUJERO Ø 2mm	SECURITY SEAL	HOLE Ø 0.08 In

DIMENSIONES GENERALES / GENERAL DIMENSIONS

BASE / BASE	DIMENSIONES / DIMENSIONS											
	LARGO (L)	120 mm	LENGHT (L)	4 In	ANCHO (W)	120 mm	WIDTH (W)	4 In	ALTURA (H)	50.5 mm	HEIGHT (H)	2 In

BASE / BASE	DIMENSIONES / DIMENSIONS											
	LARGO (L)	120 mm	LENGHT (L)	4 In	ANCHO (W)	120 mm	WIDTH (W)	4 In	ALTURA (H)	50.5 mm	HEIGHT (H)	0.75 In



INSTRUCCIONES DE MONTAJE PARA CAJAS DE PASO ADLER

ASSEMBLY INSTRUCTIONS FOR ADLER JUNCTION BOX

0 PARTES DE LA CAJA BOX PARTS

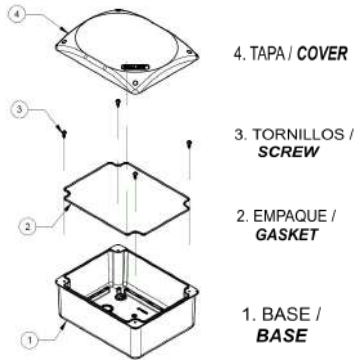

1 MARCAR POSICIÓN DE CAJA MARK POSITION OF BOX

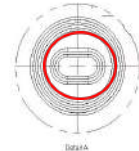
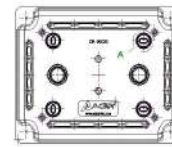
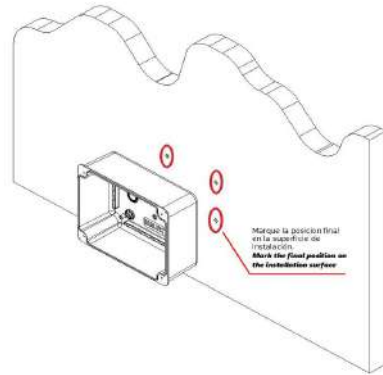

Retire las guías pretroqueladas de la base de la caja, luego marque en la superficie de instalación la ubicación final de la caja.
Remove the engraved guides of the box base, then mark on the installation surface the final location of the box.

2 FIJAR COMPONENTES ELECTRICOS FIX ELECTRICAL COMPONENTS

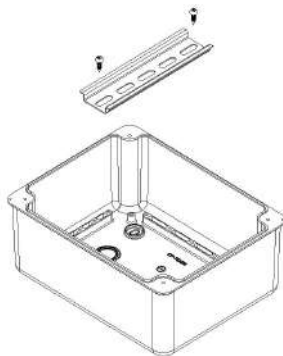

Realice agujeros en los laterales de la caja para instalar prensaestopos o bien monte el riel DIN sobre la caja para fijar los elementos eléctricos.
Make holes on box sides for installing cable glands. Also you can attach a DIN rail for installation of electrical components.

3 FIJAR LA CAJA A LA SUPERFICIE FIX BOX TO SURFACE

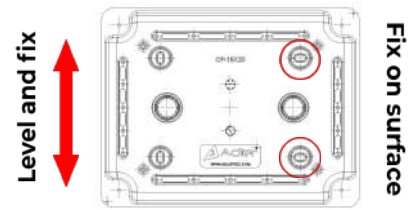

Ajuste la caja de un solo lado, utilice las ranuras de fijación para nivelar correctamente la caja y asegurela a la superficie de instalación con 4 tornillos.
Fix the box just on one side, use fitting slots for correctly leveling the box, then fix on surface with 4 screws.

4 VERIFIQUE EL EMPAQUE CHECK SEALING GASKET

Verifique que la envoltura de sellado esté correctamente posicionada en la canal de la tapa.
Check that sealing gasket is correctly positioned on the box top cover channel.

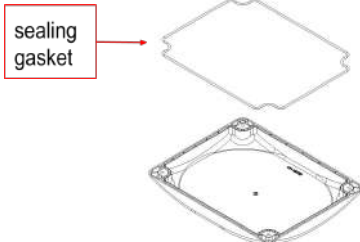

5 CIERRE DE TAPA CLOSE TOP COVER BOX

La caja incluye en el empaque 4 tornillos para fijar la tapa a la base, ajuste de forma cruzada.
Package of box includes 4 screws to fit the top cover to the base. Tighten the screws clockwise.

